

# TOPSwitch<sup>®</sup>-II Flyback

## Quick Selection Curves

### Application Note AN-21



## Introduction

This application note is for engineers starting a flyback power supply design with TOPSwitch-II. It offers a quick method to select the proper TOPSwitch-II device from parameters that are usually not available until much later in the design process. The TOPSwitch-II Flyback Quick Selection Curves provide the essential design guidance.

Efficiency and TOPSwitch-II power dissipation are two important performance parameters to the flyback power supply designer. Both can be easily measured or accurately estimated after the power supply is designed. But what if the designer must make project and resource decisions before actually committing to and starting development? This application note helps the designer quickly select the optimum TOPSwitch-II device from simple curves of estimated efficiency and TOPSwitch-II power dissipation.

## Typical Power Supply Losses

Power supplies have an input power which, because of internal dissipation, can be significantly higher than the output power. Efficiency, defined as the ratio of output power to input power, indicates how much power is dissipated in the power supply. In the typical TOPSwitch-II flyback power supply shown in Figure 1, most of the power dissipation occurs in output rectifier D2, Zener diode VR1 (or equivalent clamp circuit) and the TOPSwitch-II device. Other components, such as output filter inductor L1, input common mode inductor L2, and bridge rectifier BR1, contribute lesser power dissipation terms.

## Overview of Quick Selection Curves

The TOPSwitch-II Flyback Quick Selection Curves consider these dissipation terms (and others as well) to provide a good estimate of expected efficiency for both Universal input and 230 VAC mains applications. Figure 2 (for +12 V outputs) and Figure 3 (for +5 V outputs) show a set of curves for efficiency and TOPSwitch-II power dissipation versus output power for the entire family of TOP221-TOP227 devices. These curves assume operation from a low line AC input voltage of 85 VAC, which is a suitable value for all Universal input applications.

## QUICK START

- 1) Determine which graph (Fig. 2, 3, 4 or 5) is closest to your application.  
Example: Use Figure 2 for Universal input, 12 V output.
- 2) Find your power requirement on the X- axis.
- 3) Move vertically from your power requirement until you intersect with a TOPSwitch-II curve (solid line).
- 4) Read the associated efficiency on the Y- axis.
- 5) Determine if this is the appropriate efficiency for your application. If not, continue to the next TOPSwitch-II curve.
- 6) Read TOPSwitch-II power dissipation from the dashed contours to determine heatsink requirements.
- 7) Start the design. Use the Transformer Design Spreadsheet from AN-17.

*Note: See Selection Curve Assumptions for limits of use.*

For higher nominal mains voltages, including 208, 220, 230, and 240 VAC, a low line AC input voltage of 195 VAC is used to generate similar curves found in Figure 4 (for +12 V outputs) and Figure 5 (for +5 V outputs). For all curves, the maximum AC mains voltage is assumed to be 265 VAC.

For each TOPSwitch-II device, a family of efficiency curves (solid lines) is plotted on the Y-axis as a function of output power on the X-axis. TOPSwitch-II power dissipation is plotted separately on the same graph as a family of constant power dissipation contours (dashed lines).

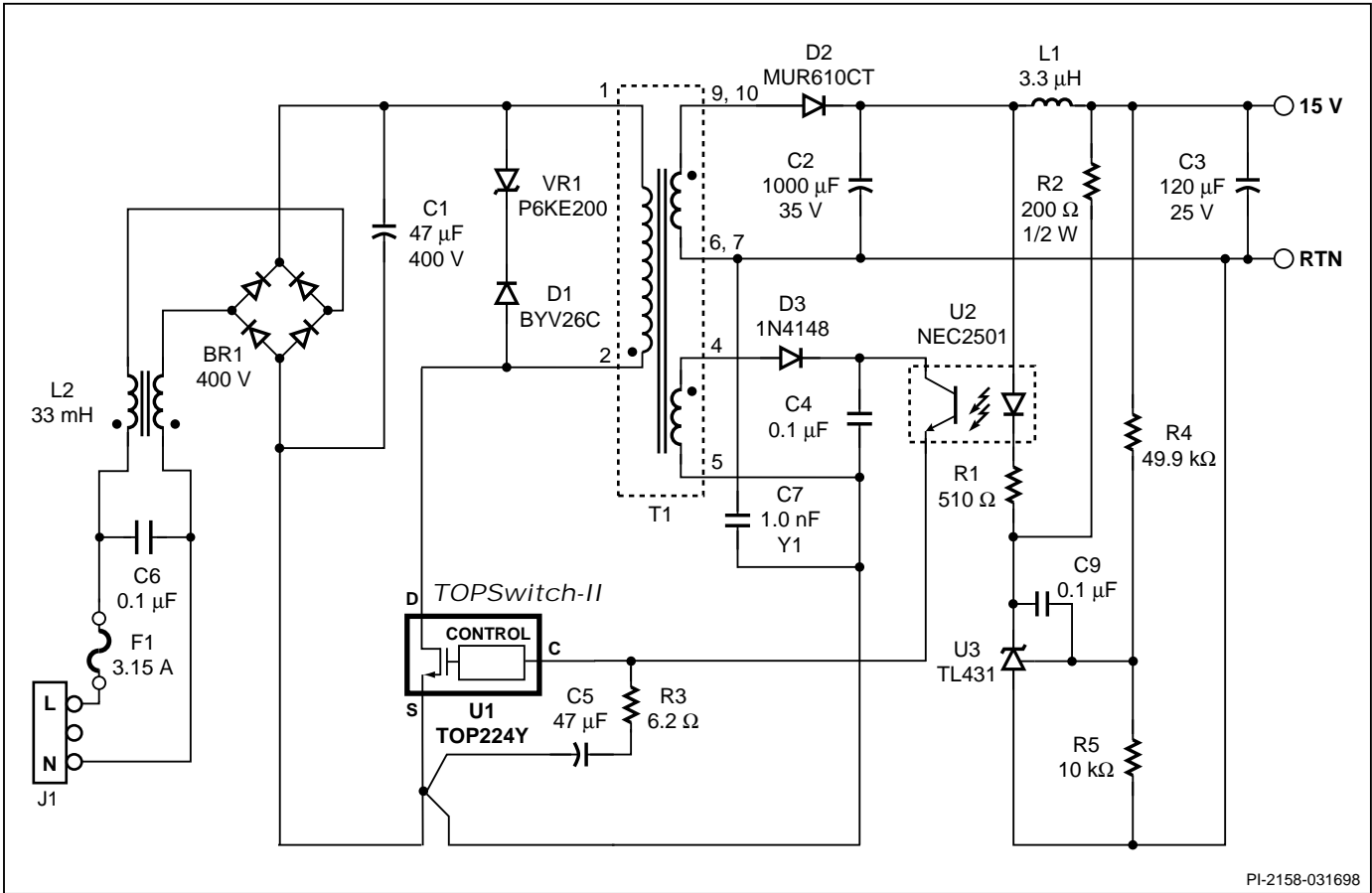

PI-2158-031698

Figure 1. Typical Flyback Power Supply Using TOP224.

## Selecting the Right TOPSwitch-II

### Using Figures 2, 3, 4 and 5

First we use the Power versus Efficiency curves to find the efficiency of the power supply for each TOPSwitch-II device that will deliver the output power. Then we estimate the TOPSwitch-II loss from the contours of constant power dissipation.

Start with the output power of the application on the X-axis. Move vertically to the intersection with the first TOPSwitch-II curve and then read the efficiency directly from the Y-axis. From the same intersection point on the TOPSwitch-II curve, interpolate the TOPSwitch-II power dissipation from the constant power dissipation contours.

Some output powers can be delivered by more than one TOPSwitch-II device. When moving vertically from the X-axis, the first curve encountered will be for the smallest, lowest cost TOPSwitch-II device, while the last curve will be for the largest, most efficient TOPSwitch-II device suitable for the desired output power.

### Example 1: 30 W Universal Application

Assume a +5 V application requires 30 W of output power from Universal input voltage. From the curves in Figure 3, the TOP224 can deliver 30 W with an estimated Y-axis efficiency of 71%. The projected TOPSwitch-II power dissipation is approximately 2.5 W. The TOP225 can also be used with an expected efficiency of 75% and interpolated power dissipation of approximately 1.7 W. With these curves, a heat sink can be selected or evaluated immediately because an estimate for TOPSwitch-II power dissipation is now available before the design is even started!

### Example 2: 30 W Application from 230 VAC

Consider a +12 V output at 30 W from 230 VAC input. Figure 4 shows the TOP223 is the optimum device with an expected efficiency slightly over 85% and power dissipation of approximately 0.75 W.

### Example 3: TOPSwitch-II Temperature

It is easy to estimate the junction temperature  $T_j$  of the



*TOPSwitch-II* from the ambient temperature  $T_A$  and the effective junction to ambient thermal impedance  $\theta_{JA}$ . This technique works for any *TOPSwitch-II* package as long as the overall thermal impedance is known, which includes the selected *TOPSwitch-II* thermal impedance, the thermal interface to a heatsink, and the effective thermal impedance of the heatsink itself. For example, with a TOP225 dissipation  $P_D$  of 1.7 W, ambient temperature  $T_A$  of 40 °C, and overall thermal impedance  $\theta_{JA}$  of 20 °C/W, the maximum *TOPSwitch-II* junction temperature  $T_J$  can be found as follows:

$$\begin{aligned} T_J &= T_A + (P_D \times \theta_{JA}) \\ &= 40 \text{ °C} + (1.7 \text{ W} \times 20 \text{ °C/W}) = 74 \text{ °C} \end{aligned}$$

The design should limit  $T_J$  to less than 100 °C at the maximum ambient temperature.

## Available Power

The minimum AC input voltage has a strong influence on the choice of *TOPSwitch-II* device for a given output power. If the minimum voltage is increased above the values assumed for the curves in Figures 2 through 5, then more power will be available from each *TOPSwitch-II* device.

We can use the Output Power Ratio Curves in Figures 6 and 7 together with the original curves of Figures 2 through 5 to determine the available power for different input voltages.

Figure 6 gives a ratio curve for 230 VAC mains at low line while Figure 7 shows a similar curve for low line Universal mains applications.

PARAMETER	VALUE
Switching Frequency ( $f_s$ )	100 kHz
Transformer Reflected Voltage ( $V_{OR}$ )	135 V
Clamp Voltage ( $V_{CLAMP}$ )	200 V
Output Schottky Rectifier Forward Voltage ( $V_D$ )	0.4 V
Primary Bias Voltage ( $V_B$ )	16 V

Table 1. Power Supply Parameters Independent of Input Voltage and Output Power.

## Adjusting for Minimum Input Voltage

### Using Figures 6 and 7

To use the power ratio curves, start on the X-axis with the desired minimum AC input voltage. Move vertically to the intersection with the curve. Read the value of the power ratio from the Y-axis. The effective output power at the originally assumed minimum mains voltage of 85 or 195 VAC is simply the actual required output power divided by this ratio.

The effective output power at 85 or 195 VAC mains voltage is used as the X-axis value for the curves given in Figures 2-5. The effective output power at 85 or 195 VAC will generate the same *TOPSwitch-II* loss (obtained from the curves in Figures 2-5) as the actual required output power at the modified AC input voltage. This ratio also scales the primary inductance to a value appropriate for the different input voltage. The original curves are derived from the typical values in Table 3, which is discussed later in this application note. In addition, *TOPSwitch-II* duty cycle limitations require a linear reduction in reflected voltage  $V_{OR}$  for AC mains voltages below 85 VAC, as shown in Figure 7.

### Example 4: Input Voltage Adjustment

Suppose an application for only the US market requires 35 W of output power at +12 V. The lowest AC input voltage is typically 90% of 115 VAC or 103.5 VAC. Find the power ratio from Figure 7 to be 1.15. The effective output power, obtained by dividing the actual output power by the power ratio, is

$$\text{Effective Output Power} = \frac{35 \text{ W}}{1.15} = 30.4 \text{ W}$$

	85 VAC	195 VAC
Optocoupler LED Current	3.5 mA	5.0 mA
Optocoupler Transistor Current	3.5 mA	5.0 mA

Table 2. Typical Power Supply Parameters that Change with *TOPSwitch-II* Duty Cycle.



### TYPICAL POWER SUPPLY COMPONENT PARAMETERS

PARAMETER	UNITS	TOP221	TOP222	TOP223	TOP224	TOP225	TOP226	TOP227
Transformer Primary Inductance	μH	8650	4400	2200	1475	1100	880	740
Transformer Leakage Inductance (referred to the primary)	μH	175	90	45	30	22	18	15
Transformer Resonant Frequency (measured with secondary open)	kHz	400	450	500	550	600	650	700
Transformer Primary Winding Resistance	mΩ	5000	1800	650	350	250	175	140
Transformer Secondary Resistance	mΩ	20	12	7	5	4	3.5	3
Output Capacitor Equivalent Series Resistance	mΩ	30	24	18	15	13	11.5	10
Output Inductor DC Resistance	mΩ	40	32	25	20	16	13	10
Common Mode Inductor DC Resistance	mΩ	400	370	333	300	267	233	200

Table 3. Typical Power Supply Component Parameters for TOPSwitch-II Flyback Power Supply.

This effective output power is then used with the curves in Figure 2 to select the *TOPSwitch-II* device and to estimate the *TOPSwitch-II* dissipation. Predictions of efficiency and power dissipation may be less accurate when the ratio is used. The new value of primary inductance is the product of the power ratio and original inductance value in Table 3. The new inductance value for the TOP224 would be:

$$L_p = 1475 \mu\text{H} \times 1.15 = 1696 \mu\text{H}$$

## Selection Curve Assumptions

Several physical power supply parameters must be calculated, estimated, or measured to determine efficiency. Measured values can differ significantly from the curves' predictions if the design parameters are not the same as the typical values used to generate the curves.

Typical values are given in Table 1 for several parameters that are independent of power level and input voltage. These parameters are defined and discussed in AN-16 and AN-17.

Typical values are given in Table 2 for two parameters that

depend only on input voltage. These parameters change with *TOPSwitch-II* duty cycle.

The remaining power supply parameters depend on the output power. Table 3 gives typical values for the power-dependent parameters

## Input Capacitance

Efficiency and output power are both strong functions of bulk energy storage capacitor C1. For the Universal AC Mains curves, the numerical value of C1 in microfarads is assumed to be at least three times the maximum output power in watts. For 230 VAC mains, the C1 value (μF) is assumed to be at least equal to the maximum output power (watts).

For example, for 30 W of output power, the bulk energy storage capacitor C1 is expected to be at least 90 μF for Universal mains and 30 μF for 230 VAC mains applications. The design must consider the tolerance of the capacitor to guarantee expected performance from the power supply.

Lower values of input capacitance will reduce the available



output power. Going from 3 to 2  $\mu\text{F}$  per watt will decrease the output power by as much as 15% for Universal input. The available power falls dramatically for values less than 2  $\mu\text{F}$  per watt.

The value of capacitor C1 also determines the average value of the DC bus voltage. The Universal VAC Mains curves in Figures 2 and 3 were generated with an average DC bus value of 105 VDC while the 230 VAC Mains curves in Figures 4 and 5 were generated with an average DC bus value of 265 VDC.

## Other Considerations

Curves in this application note were generated from the typical power supply parameters in Tables 1, 2 and 3. If measured efficiency in a particular *TOPSwitch-II* application does not agree with the values predicted from the curves, it is likely the physical parameters of the measured power supply do not match the tabular values. Use the guidelines below to get best agreement between measurements and predictions.

- When measuring efficiency from an AC source, use an electronic wattmeter designed for average input power measurements with high-crest factor current waveforms. Do not simply measure RMS input voltage and RMS input current. The product of these two measurements is input volt-amperes or input burden (VA), not the real input power in watts.

- Use a DC voltage source to prevent AC ripple voltage from modulating the duty cycle. Efficiency depends heavily on actual DC input voltage. A convincing experiment is to vary the DC voltage  $\pm 15$  V to see how efficiency varies over the range of expected AC ripple voltage.
- Measure transformer leakage inductance accurately. Take into account inductance of external circuitry, which can increase effective leakage inductance by 30% or more.
- Measure switching frequency accurately for the individual *TOPSwitch-II* in the circuit to account for component-to-component variations.
- Verify actual clamp voltage. Effective clamp voltage can be 230 VDC or higher, even though the clamp Zener diode is specified to be 200 V. See AN-16 for details.

Determine which physical power supply parameters do not match the typical values in Table 3. Change (temporarily) to components that match the parameters in the table until measured efficiency matches the predicted value.



UNIVERSAL INPUT (85 VAC TO 265 VAC) 12 V OUTPUT

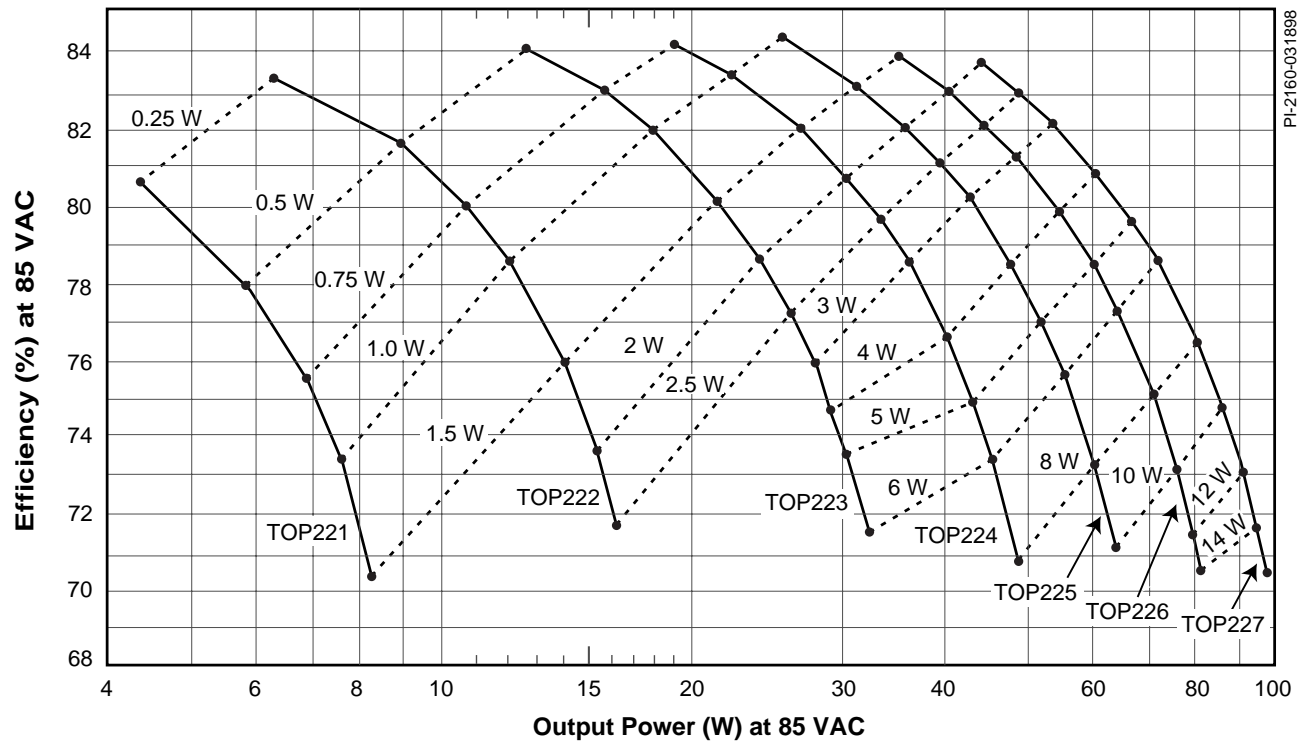

Figure 2. Typical Efficiency vs Output Power with Contours of Constant TOPSwitch-II Power Loss for Universal Input and 12 V Output.

UNIVERSAL INPUT (85 VAC TO 265 VAC) 5 V OUTPUT

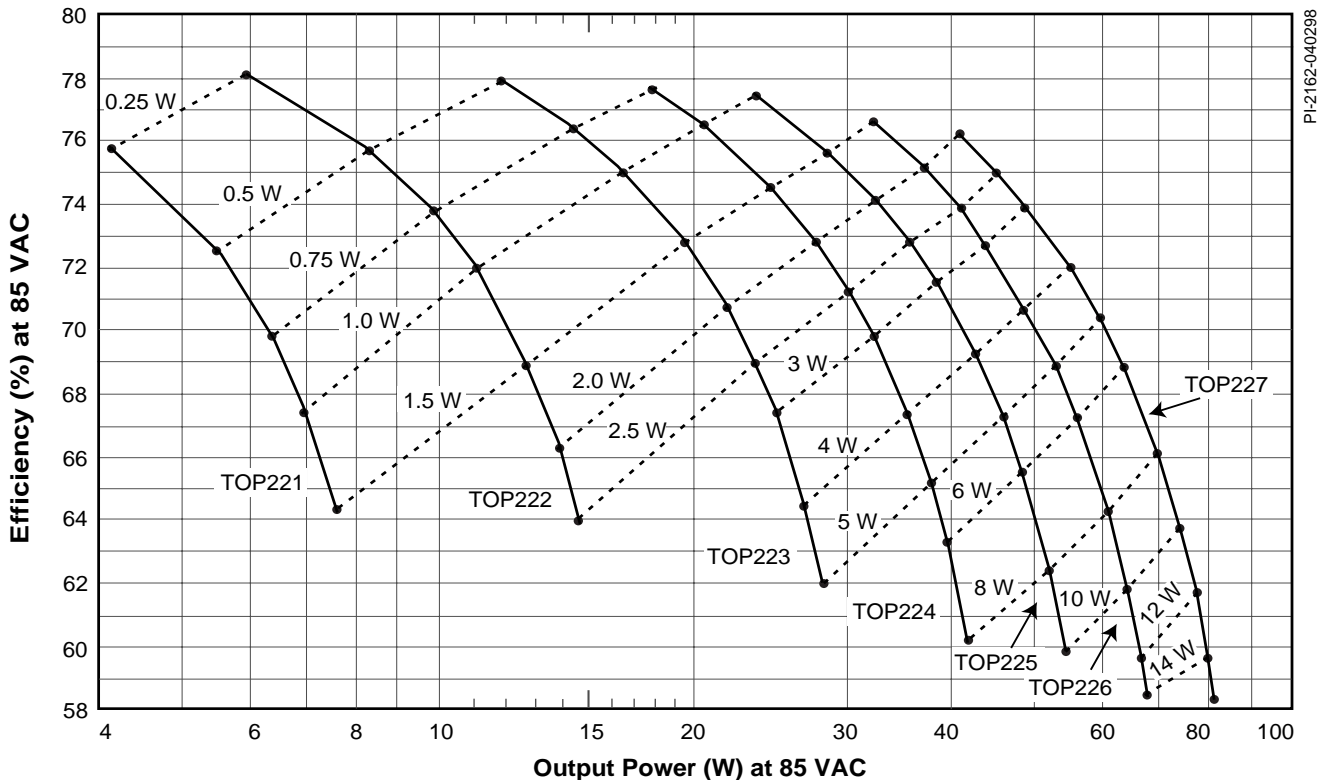

Figure 3. Typical Efficiency vs Output Power with Contours of Constant TOPSwitch-II Power Loss for Universal Input and 5 V Output.



**SINGLE VOLTAGE INPUT (230 VAC ±15%) 12 V OUTPUT**

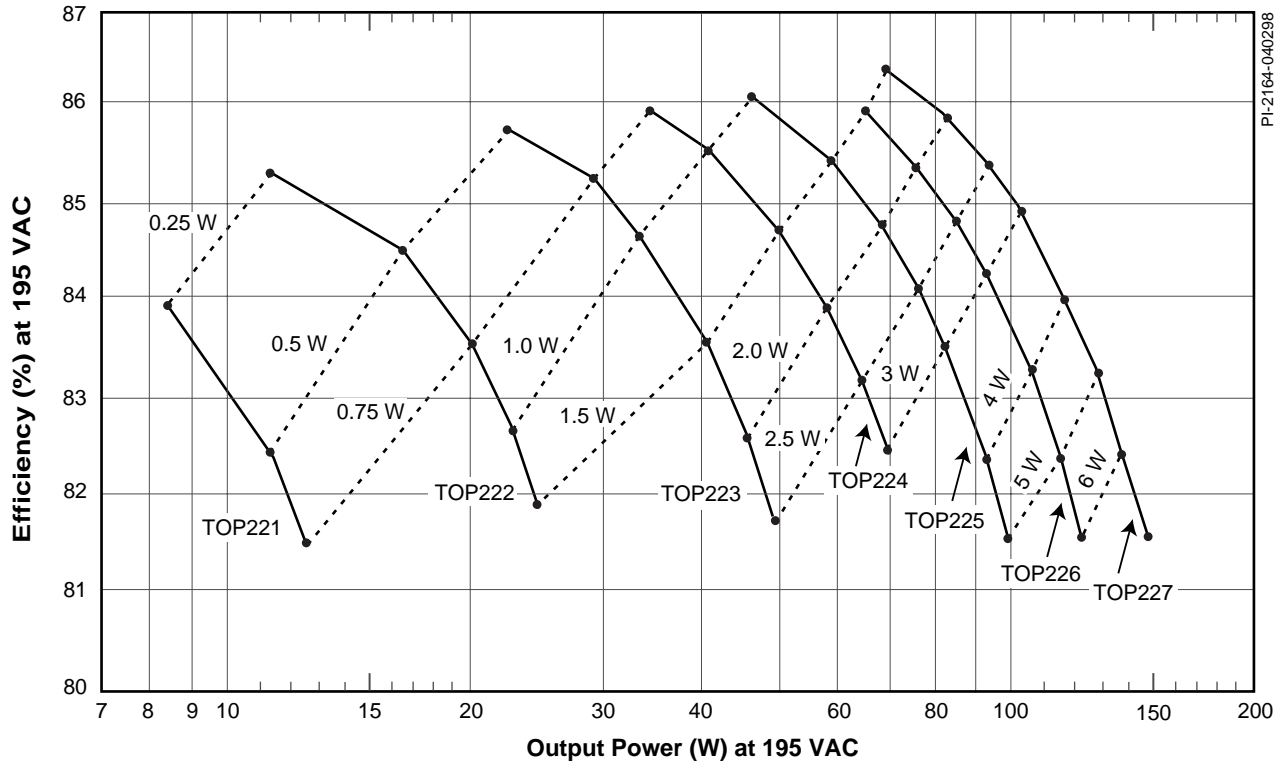

Figure 4. Typical Efficiency vs Output Power with Contours of Constant TOPSwitch-II Power Loss for Single Voltage Application and 12 V Output.

**SINGLE VOLTAGE INPUT (230 VAC ±15%) 5 V OUTPUT**

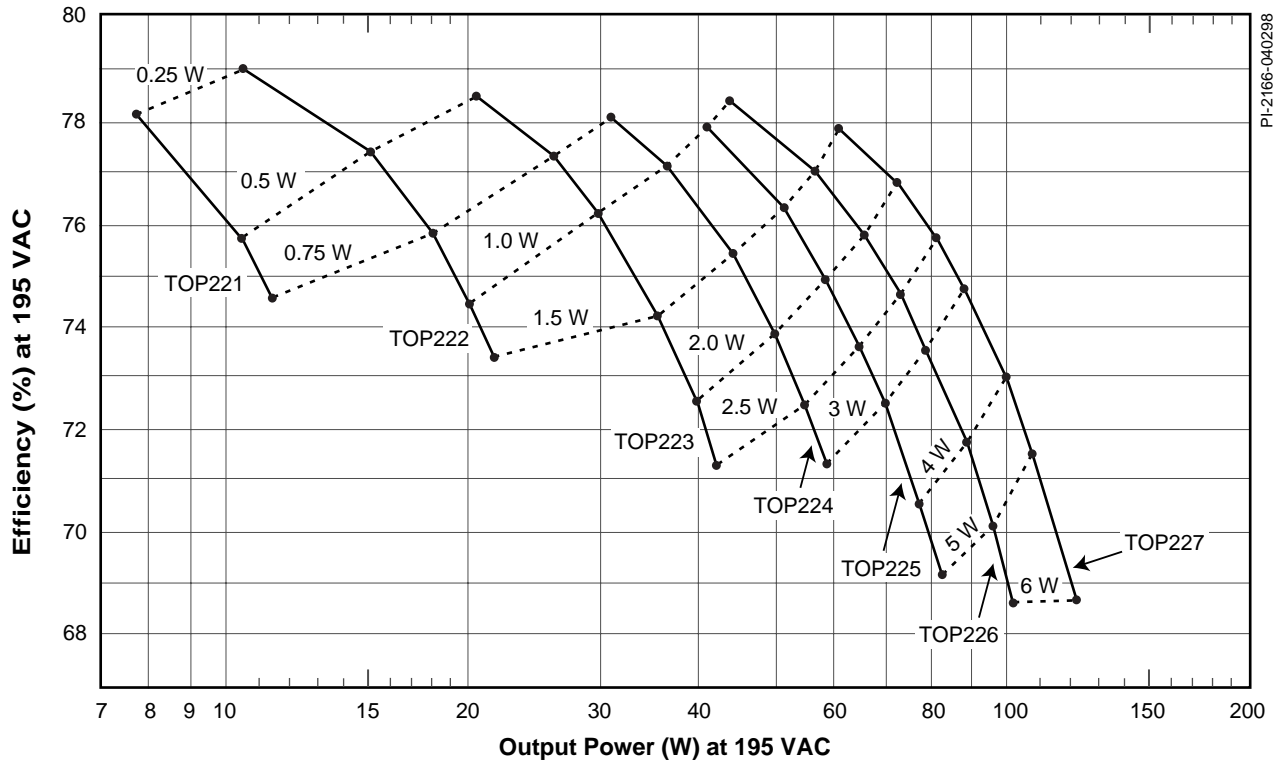

Figure 5. Typical Efficiency vs Output Power with Contours of Constant TOPSwitch-II Power Loss for Single Voltage Application and 5 V Output.



**POWER RATIO: SINGLE VOLTAGE (230 VAC ±15%)**

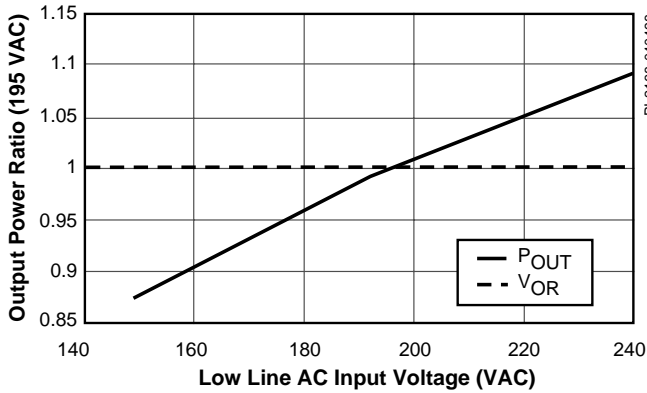

Figure 6. Power Ratio vs Low Line AC Input Voltage of Nominal 230 VAC.

**POWER RATIO: UNIVERSAL INPUT (85 TO 265VAC)**

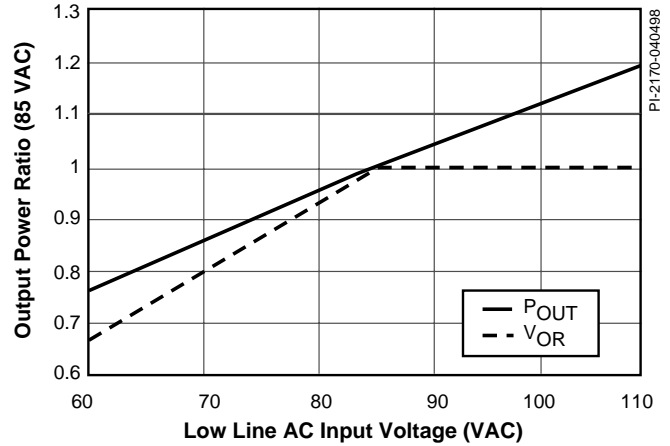

Figure 7. Power Ratio and  $V_{OR}$  vs Low Line AC Input Voltage for Universal Input.

Power Integrations reserves the right to make changes to its products at any time to improve reliability or manufacturability. Power Integrations does not assume any liability arising from the use of any device or circuit described herein, nor does it convey any license under its patent rights or the rights of others.

PI Logo and *TOPSwitch* are registered trademarks of Power Integrations, Inc.

©Copyright 1998, Power Integrations, Inc. 477 N. Mathilda Avenue, Sunnyvale, CA 94086 <http://www.powerint.com>

**WORLD HEADQUARTERS**  
**NORTH AMERICA - WEST**  
 Power Integrations, Inc.  
 477 N. Mathilda Avenue  
 Sunnyvale, CA 94086 USA  
 Main: +1•408•523•9200  
 Customer Service:  
 Phone: +1•408•523•9265  
 Fax: +1•408•523•9365

**NORTH AMERICA - EAST**  
**& SOUTH AMERICA**  
 Power Integrations, Inc.  
 Eastern Area Sales Office  
 1343 Canton Road, Suite C1  
 Marietta, GA 30066 USA  
 Phone: +1•770•424•5152  
 Fax: +1•770•424•6567

**EUROPE & AFRICA**  
 Power Integrations (Europe) Ltd.  
 Mountbatten House  
 Fair Acres Windsor  
 Berkshire SL4 4LE,  
 United Kingdom  
 Phone: +44•(0)•1753•622•208  
 Fax: +44•(0)•1753•622•209

**TAIWAN**  
 Power Integrations International  
 Holdings, Inc.  
 2F, #508, Chung Hsiao E. Rd., Sec. 5,  
 Taipei 105, Taiwan  
 Phone: +886•2•2727•1221  
 Fax: +886•2•2727•1223

**KOREA**  
 Power Integrations International  
 Holdings, Inc.  
 Rm# 402, Handuk Building,  
 649-4 Yeoksam-Dong, Kangnam-Gu,  
 Seoul, Korea  
 Phone: +82•2•568•7520  
 Fax: +82•2•568•7474

**JAPAN**  
 Power Integrations, K.K.  
 Keihin-Tatemono 1st Bldg.  
 12-20 Shin-Yokohama 2-Chome,  
 Kohoku-ku, Yokohama-shi,  
 Kanagawa 222, Japan  
 Phone: +81•(0)•45•471•1021  
 Fax: +81•(0)•45•471•3717

**INDIA (Technical Support)**  
 Innovatech  
 #1, 8th Main Road  
 Vasanthnagar  
 Bangalore 560052, India  
 Phone: +91•80•226•6023  
 Fax: +91•80•228•2191

**APPLICATIONS HOTLINE**  
 World Wide +1•408•523•9260

**APPLICATIONS FAX**  
 World Wide +1•408•523•9361

